

# WEBER CARBURETOR CONVERSION KIT INSTALLATION GUIDE

**PART # WK553**

THIS KIT IS FOR THE FOLLOWING APPLICATIONS:

Jeep Models Originally equipped with the  
Carter 1BBL Carburetor 1945 -1971

Thank you for purchasing a Weber carburetor conversion kit. These kits are designed to enhance the performance of your engine while maintaining both reliability and fuel efficiency.

This installation guide covers vehicle preparation, old carburetor removal, carburetor installation, and new carburetor adjustments. A trouble-shooting guide is supplied.

Before installation please read this guide thoroughly. If you have any questions please call our Toll Free Technical Line at 1 (800) 871-3405.

**Please pay extra attention to any items in BOLD FACE TYPE and with a  next to it . This will help to insure an error free installation with optimal vehicle performance.**

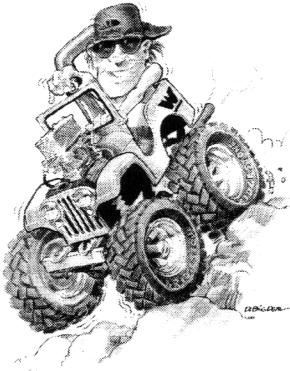

**THIS CARBURETOR CONVERSION KIT  
INCLUDES:  
A NEW 32/36 DGV Manual Choke Carburetor  
MANIFOLD BASE ADAPTER  
HARDWARE KIT  
CHROME AIR CLEANER**



The Following is a List of the Tools that will be needed to install this conversion kit:

- Socket and Wrench Set
- Allen Key Set 3/16" and 5 mm
- Screwdrivers
- Pliers (needle nose)
- Gasket Scraper
- Wire Brush

The Following is a list of supplies that are needed to install this conversion kit:

- Carburetor Cleaner
- Clean Rags
- Engine Cleaner
- Aluminum Foil
- Tags (these are needed to label hoses etc.)
- Loctite for manifold and base adapter bolts and studs.

The Following is a list of optional items that are very helpful in installing this conversion kit:

- Vacuum Gauge/ Tester
- Fuel Pressure Gauge/ Tester
- Flashlight
- Magnet
- Vehicle Shop Manual
- Haynes Weber Book HM393
- HP Weber Book HP774

**Legal in California only on off road vehicles .**

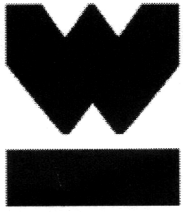

# WEBER CARBURETOR CONVERSION KIT INSTALLATION GUIDE

## FOR SAFETY PURPOSES:

- **USE CLAMPS ON ALL FUEL HOSES.**
- **DO NOT USE GASKET SEALERS, USE GASKETS PROVIDED.**
- **WHEN REMOVING OLD CARBURETOR LABEL ALL HOSES AND WIRES.**
- **IF NECESSARY CLEAN ENGINE BEFORE INSTALLATION.**
- **USE LOCTITE ON HARDWARE INSIDE AIR CLEANER AND INTAKE MANIFOLD STUDS.**
- **IF REWIRING IS NEEDED ALWAYS USE AN INSULATED CONNECTOR OR TAP.**
- **NEVER ALLOW DIRT IN THE CARBURETOR.**
- **DO NOT OVERTIGHTEN JETS OR THROTTLE LINKAGE.**
- **NEVER OPERATE THE ENGINE WITHOUT A FUEL FILTER.**
- **DO NOT ALLOW FUEL TO SPILL OR LEAK.**
- **BE CAREFUL NOT TO CUT OR DENT THE ALUMINUM GASKET SURFACES OF THE INTAKE MANIFOLD OR CARBURETOR.**
- **ALWAYS WEAR EYE PROTECTION.**

## **This section should be completed before you install this Weber Conversion Kit.**

- Please make sure that the Parts were not damaged in shipment.
- Please check the contents of the kit against the contents listed on page 1.
- If any parts were missing or the parts were damaged in shipping please contact the Weber Tech department at 1 800 871 3405.
- Replace the fuel filter.
- Verify that the vehicle had a recent tune up and that you do not have any mechanical problems.
- Weber Carburetors require 3.5 p.s.i. of Fuel pressure. If your fuel pressure is more than 3.5 p.s.i, obtain a Fuel Pressure Regulator from your Weber Dealer.
- Weber Carburetors are preset at the Factory.  
Only make adjustments to the carburetor after the installation, and running the vehicle for the first time. After the carburetor is installed record the factory settings if needed in the future.
- Make sure that you have the Tools and Supplies available as described on page 1.
- Please save your sales receipt and all carburetor documentation for future reference.

**Please pay extra attention to any items in BOLD FACE TYPE and with a  next to it . This will help to insure an error free installation with optimal vehicle performance.**

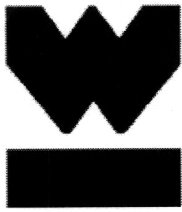

# WEBER CARBURETOR CONVERSION KIT INSTALLATION GUIDE

## REMOVAL OF OLD CARBURETOR

- Remove the Battery's negative cable.
- Take off the original Air Cleaner Assembly.
- Remove the gas cap.
- Remove the Fuel Supply hose that is attached to the carburetor  
Label it and temporarily plug it to prevent fuel leaks.
- Remove the Fuel Return hose (if equipped) and plug it.
- Remove and label the vacuum hoses connected to the carburetor.
- Remove and label all of the electrical connectors attached to the carburetor.  
Identify the electric choke wire. This wire will be reused.
- Remove the Float bowl Vent hose and label it.
- Remove the throttle linkage from the carburetor.
- Remove carburetor and all spacers and gaskets from the intake manifold. Save carburetor mounting nuts for use in installing the adapter to the intake manifold. Place a clean rag in the intake opening to keep dirt and tools etc. out.



**DO NOT FORGET TO REMOVE THE RAG BEFORE INSTALLING THE WEBER CARBURETOR**



- Remove any excess gasket material from intake manifold. You can use a gasket scraper, wire brush and carburetor cleaner.



**DO NOT USE A WIRE WHEEL OR ANY POWER TOOLS AS THEY MAY DAMAGE THE MANIFOLD**



## WEBER CARBURETOR INSTALLATION

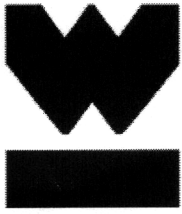

- Remove the adapter from the bag and install the 1/8 " X 3/8" brass fitting using loctite.
- Take the small base gasket and mount it on the intake manifold.
- Install the adapter onto the intake manifold making sure that the brass fitting faces the front of the vehicle.

Please pay extra attention to any items in **BOLD FACE TYPE** and with a  next to it . This will help to insure an error free installation with optimal vehicle performance.



# WEBER CARBURETOR CONVERSION KIT INSTALLATION GUIDE

## WEBER CARBURETOR INSTALLATION (continued)

- Install the Weber Carburetor on the four mounting studs. Carburetor linkage facing the firewall. Use the four 8mm bolts to secure the carburetor to the adapter using the large washers supplied between the head of the bolts and the underside of the adapter. At the same time if necessary install the linkage bracket on the two bolt holes closest to the left fender. using a criss-cross pattern tighten evenly.
-  **DO NOT OVERTIGHTEN** 
- At this time check that the linkage is not binding. Hold the choke plates open to make sure that the throttle opens and closes freely.
- Attach the cable to the ball on the throttle lever. Or if you do not have a socket on your cable end use the cable trunion provided and use c clip to attach to the throttle arm. Make sure that the throttle operates smoothly and correct if necessary. On some applications it may be necessary to relocate the throttle cable. Use the bracket provided and install on the back carburetor studs that face the drivers side fender. . We have provided an alternate return spring in the kit. Install the bracket on the carburetor mounting stud on the back of the carburetor. Attach the spring to the lower lever on the carburetor and the bracket .
- On some models linkage Fabrication is required.
- Locate the PCV hose and attach it to the fitting in the adapter. If you have power brakes you must tee the power brake hose with the PCV.
- Locate the vacuum advance hose and connect it to the vacuum advance port on the carburetor. (see Pictures 1 and 2)
- A Choke cable is provided if you need to replace an old worn out cable.
- Locate any open vacuum ports and hoses and plug them. (check local laws)
- At this point make sure that all hose clamps are tightened and that all of the electrical connectors are connected and insulated.
- Reconnect the Battery's negative cable.
- Crank Engine without starting and check for fuel leaks.

 **DO NOT GO ANY FURTHER WITHOUT INSPECTING AND FIXING** 

Please pay extra attention to any items in **BOLD FACE TYPE** and with a  next to it . This will help to insure an error free installation with optimal vehicle performance.

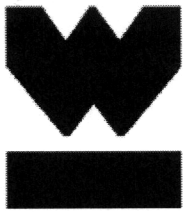

# WEBER CARBURETOR CONVERSION KIT INSTALLATION GUIDE

## WEBER CARBURETOR INSTALLATION (continued)

- Remove Air cleaner from packaging. Connect plastic breather tube to air filter base and bolt air filter base to carburetor using the four screws provided.
- Attach the breather hose from the valve cover to the air cleaner.
- Put the air filter element on the air filter base and attach the air cleaner top with the clips provided.
- To check the clearance between the hood and air filter, place some crumpled up aluminum foil on the air cleaner top and slowly lower the hood and check clearance.

### **CARBURETOR ADJUSTMENTS (see pictures for identification of components)**

- Only make the adjustments discussed here if necessary.
- To adjust the idle speed make sure that the engine is warm, set the speed to the vehicle manufacturer's setting. To raise the speed turn the idle screw (clockwise) in, and to lower the speed turn the speed screw (counter clockwise) out.
- To adjust the idle mixture turn the idle mixture screw in slowly (clockwise) counting the amount of turns you make until the idle speed drops off. Turn the screw out (counter clockwise) counting the turns until the idle drops off again. Turn the screw back in half the distance that you turned it out. Now the mixture is set.
- To adjust the fast idle make sure that the engine is cold. Press the accelerator pedal to the floor and let go. Start the engine (do not touch the accelerator pedal) once you touch the accelerator after the engine is running the fast idle cam is disengaged. The engine should be running between 2000 and 2500 Rpm's. Turn off the engine. To adjust the fast idle speed turn the fast idle screw in (clockwise) to increase engine RPM, to decrease engine RPM turn the fast idle screw out (counterclockwise) Do not touch the accelerator and restart engine to check RPM.
- The electric choke is pre-set. To adjust the electric choke make sure that the engine is cool (below 68F) Turn the throttle linkage all the way open to set the choke. The plates should be closed. Make a mark on the plastic choke cap and the carburetor where the two surfaces meet. Loosen the three screws one turn. Hold the throttle about one third open and start twisting the thermostat cap (counter clockwise) until the choke plates fully close, then slowly turn the cap 1/8" (you should feel the spring tension in the choke tightening). Retighten the three screws (do not over tighten). You may now have to go back and check the fast idle speed and adjust if necessary.

Please pay extra attention to any items in **BOLD FACE TYPE** and with a  next to it . This will help to insure an error free installation with optimal vehicle performance.

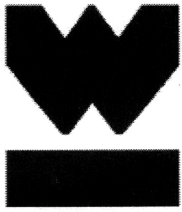

# WEBER CARBURETOR CONVERSION KIT INSTALLATION GUIDE

## TROUBLE SHOOTING GUIDE

**In order to properly trouble shoot any suspected carburetor problems please double check the following:**

Please read through the Weber Carburetor Installation section. Go over any item that has **BOLD FACE TYPE**  
Or has a  next to it.

**If the vehicle will not start please check the following:**

Check that the fuel pump is functioning properly. Check with pressure gauge.

Make sure that the ignition system is functioning properly.

**If the engine idles too fast or too slow or stalls please check the following:**

Make sure that you have no vacuum leaks. You should check all engine vacuum line connections and at the carburetor base (including the adapter plates).

Check all Carburetor adjustments. Idle mixture, idle speed, and fast idle. In this order.

**If the engine idles fine but acts as if it is running out of fuel when driving please check the following:**

If new fuel filter was not installed install one now. The old fuel filter may be clogged.

Check that the fuel pump is functioning properly. Check with pressure gauge.

Check all fuel lines. Make sure that the lines are not pinched or kinked.

Check that the vehicle has not run out of gas.

Check the fuel tank venting system. (Refer to vehicle shop manual)

**If the engine runs rough or sounds like it is missing at idle please check the following:**

Make sure that you have no vacuum leaks. You should check all engine vacuum line connections and at the carburetor base (including the adapter plates).

Check the idle mixture adjustment.

**If you were not able to correct the problem with the information provided above contact your Weber Dealer or call our Toll Free Techline line at 1 800 871-3405.**



**Any additional engine modifications such as Headers, Hi Performance camshafts, and free flow exhaust systems may require that the carburetor be recalibrated.**

**If this is the case please contact your Weber Dealer or call our Toll Free Techline line at 1 800 871-3405.**

**Please pay extra attention to any items in BOLD FACE TYPE and with a  next to it . This will help to insure an error free installation with optimal vehicle performance.**

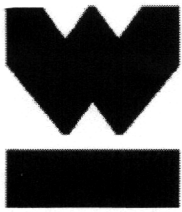

# WEBER CARBURETOR CONVERSION KIT INSTALLATION GUIDE

## 32/36 DGEV CARBURETOR( Electric Choke Carburetors Shown)

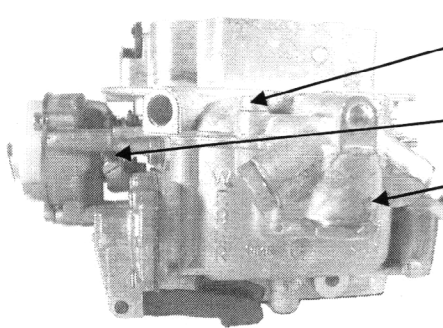

Picture 1A

- Float Bowl Vent (shown w/o fitting)
- Fast Idle Screw
- Fuel Filter Inspection Plug
- Fuel Inlet
- Electric Choke
- Idle Speed Screw
- Vacuum Advance Port
- Ported Vacuum Source
- Idle Mixture Screw

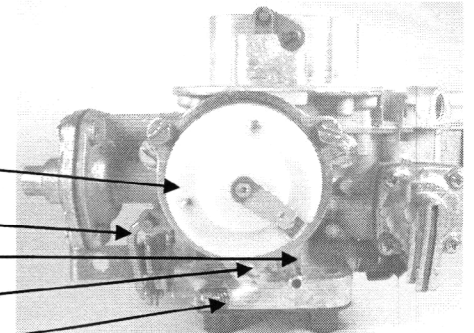

Picture 2A

## 38 DGES CARBURETOR

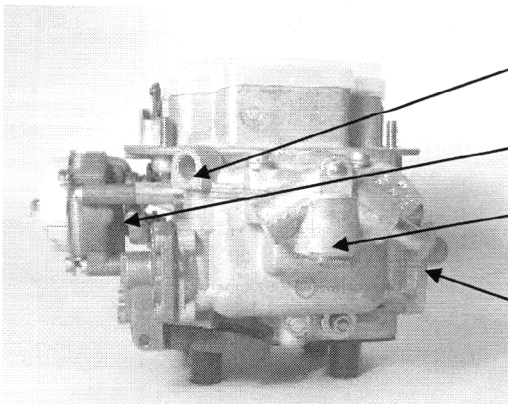

- Float Bowl Vent (shown w/o fitting)
- Fast Idle Screw
- Fuel Filter Inspection Plug
- Fuel Inlet
- Electric Choke
- Idle Speed Screw
- Vacuum Advance Port
- Idle Mixture Screw

